

P/N

SR-BASE 031

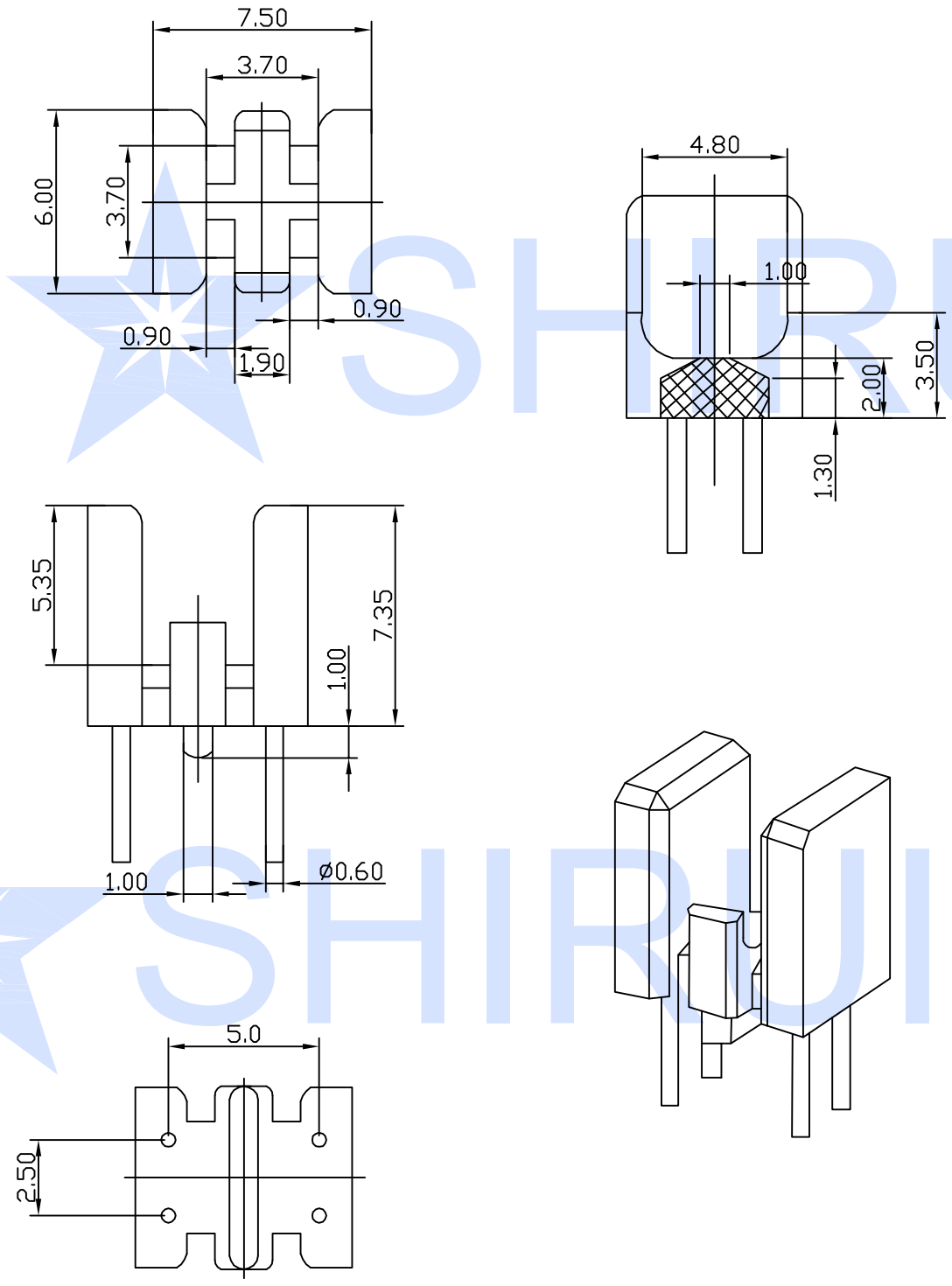

Hefei Shirui Electronic Technology Co.,Ltd

TEL:(0086) 55165232650

sales@shiruitech.com

www.shiruitech.com

SR NO. SR-BASE 031	MATERIAL: PHENOLIC	UNIT: mm	TOLERANCE	DRN.	WILL H
MODEL NAME! BASE-4PIN	UL REC: UL 94V-0		0 L ≤ 4 ± 0.10	CHD.	IRINA LEE
	ANGLE: \pm ° 		4 L ≤ 6 ± 0.20	ISSD.	JAMES HU
	SCALE 1:1		16 L ≤ 64 ± 0.30		
			PIN PITCH ± 0.05		